

# Instruction Manual



## RING BLOW VFZ Standard Model Series

Alarm

Caution



### CAUTION

- Read the instruction manual carefully before you install, put into operation and maintain the Ring Blow and handle it properly.
- For the sake of safety, never modify the Ring Blow.  
We take no responsibility for the troubles caused by repairing or modifying the product.
- Hand over this instruction manual surely to the end users, who actually install, operate and maintain the Ring Blow.
- After having read the instruction manual, keep it at the place, where can be accessed by the persons, who use it.
- The specification of the product may be changed without prior notification.

Atai Fuji Motor Co., Ltd.

## Introduction

Thank you for your purchasing of the Ring Blow.

It is required for the Ring Blow for give full play to its performance, for preventing troubles from occurring and for continuing its satisfactory operation for a long period not only to maintain and inspect it after putting it into service but also to handle it properly in every stage after its delivery until its actual operation.

This instruction manual illustrates the essential items for handling the Ring Blow.

If you find any question, please inquire of our special agent, dealer or business office about it.

## Cautions for safety

- Read this instruction manual and the other attached documents carefully before you use (install, transport, maintain, inspect etc.) the Ring Blow and then use it properly. Acquire first the machine knowledge, safety information and all caution items and use the machine. Keep this instruction manual at the place, where can be accessed by the persons, who use it.
- The ranks for safety items are classified into alarms and cautions and described in this instruction manual.



**Alarm**

: those items, for which the possibility of human **DEATH** and **HEAVY INJURY** are feared, if they are mishandles.



**Caution**

: those items, for which hazardous condition may occur and **MEDIUM HAZARD** and **SLIGHT INJURY** are feared and/or material damage are feared, if they are mishandles.

Even those items marked with



**Caution**

may lead to serious results depending upon the situation.

As every item describes serious contents, be sure to keep it always.

Furthermore, the following symbols are applied according to necessity in this instruction manual, so that the essential points of indication can be grasped at a glance.

Symbol	Meaning
	Notification of a general prohibition
	Always connect a protective earthing terminal!
	Take care of an electrical shock!

Symbol	Meaning
	Do not touch!
	Take care of ignition!
	Take care of a high temperature!



## Alarm

General	<ul style="list-style-type: none"><li>• The works of transport, installation, piping, wiring, operation, control, maintenance and inspection may only be executed by the experts, who are well skilled of handling the Ring Blows. Otherwise, an <b>ELECTRIC SHOCK</b>, an <b>INJURY</b> or a <b>FIRE</b> is feared.</li><li>• Hot line works are forbidden. Work always with the power supply switched off. Otherwise, an <b>ELECTRIC SHOCK</b> or a <b>FIRE</b> is feared.</li><li>• Do not use the Ring Blow in an explosive atmosphere. Otherwise, an <b>INJURY</b> or a <b>FIRE</b> is feared.</li></ul>
Installation, Adjustment	<ul style="list-style-type: none"><li>• Ground the protective earthing terminal surely. Otherwise, an <b>ELECTRIC SHOCK</b> or a <b>FIRE</b> is feared.</li><li>• In the Ring Blow is used as mounted on a ceiling or a wall, its fall is feared depending on its mounting condition. Observe the catalog or instruction manual for the details of usable range. An <b>INJURY</b> due to a <b>FIRE</b> is feared.</li></ul>
Piping, Wiring	<ul style="list-style-type: none"><li>• Connect it to the power supply cable according to the wiring diagram within terminal box and the instruction manual. An <b>ELECTRIC SHOCK</b> or a <b>FIRE</b> due to incorrect connection is feared.</li><li>• Use it always at the voltage and frequency indicated in the nameplate on its main body. A <b>BURNOUT</b> or a <b>FIRE</b> is feared.</li><li>• Do not bend, stretch or pinch the power supply cable and the lead wire for the Ring Blow by force. An <b>ELECTRIC SHOCK</b> or a <b>FIRE</b> is feared.</li><li>• Restore the cover for terminal box to the original position after completion of every work. Otherwise, an <b>ELECTRIC SHOCK</b> is feared.</li><li>• Dismount the emblem for middle bracket surely before installing the main body. Otherwise, a <b>BURN</b> or an <b>INJURY</b> is feared.</li></ul>
Operation	<ul style="list-style-type: none"><li>• Never access or touch any rotating body (cooling fan etc.) during running. A <b>CATCH-IN</b> on an <b>INJURY</b> is feared.</li><li>• Switch off the power supply always in case of power failure. An <b>INJURY</b> is feared due to sudden work of the machine at restoration of power supply.</li><li>• Switch off the power supply always when the Ring Blow is stopped because the protection unit belonging to it worked. An <b>INJURY</b> is feared due to sudden work of Ring Blow at recovery of the protection unit.</li></ul>



## Caution

General	<ul style="list-style-type: none"><li>• Do not use the Ring Blow out of the specifications described in the nameplate, catalog and instruction manual. An <b>ELECTRIC SHOCK</b>, an <b>INJURY</b> or a <b>DAMAGE</b> is feared.</li><li>• Do not use the damaged Ring Blow. An <b>ELECTRIC SHOCK</b>, an <b>INJURY</b> or a <b>FIRE</b> is feared.</li><li>• Do not insert any foreign material or finger into the opening (opening in fan cover, admission and discharge ports) of Ring Blow. An <b>ELECTRIC SHOCK</b> an <b>INJURY</b> or <b>DAMAGE</b> is feared.</li><li>• We take no responsibility for modification by the customer, as they are out of the scope of our responsibility.</li></ul>
---------	--

## Caution

Transportation	<ul style="list-style-type: none"> <li>• Take full care of fall and tumbling down during transportation. An <b>INJURY</b> is feared.</li> <li>• Lift up the Ring Blow equipped with a hanger bolt always after getting rid of loosening of the hanger bolt. But after mounting the Ring Blow on a machine, do not lift up the entire machine using the mounted hanger bolt. Verify the mass of motor based in the nameplate, package box, outline drawing, catalog or the like before lifting it and do not lift any more mass than the rated load of lifting tool. The gravity center of the Ring Blow is located at motor side, therefore, the Ring Blow inclines to one side during lift-up. Exert tension gradually on the wire and do not lift up suddenly. This lift-up work may only be executed by the qualified workers. Do not stay under the Ring Blow during the lifting work. An <b>INJURY</b> or <b>FIRE</b> caused by <b>FALL</b> or <b>TUMBLING DOWN</b> is feared for all of these cases.</li> <li>• Ambient temperature should be kept <math>-20^{\circ}\text{C}\sim+60^{\circ}\text{C}</math> during transportation.</li> </ul>
Opening the Package	<ul style="list-style-type: none"> <li>• Open the package after verifying the top and bottom of product. An <b>INJURY</b> is feared.</li> <li>• Open the wooden frame package taking care of the used nails. Wear glove when opening the wooden package. An <b>INJURY</b> is feared.</li> <li>• Verify if the product is just the ordered one. An <b>INJURY</b>, <b>DAMAGE</b> or a <b>FIRE</b> due to use of the incorrect product is feared.</li> </ul>
Installation, Adjustment	<ul style="list-style-type: none"> <li>• Never place any inflammable material around the Ring Blow. A <b>FIRE</b> is feared.</li> <li>• Do not place any obstacle against ventilation around the Ring Blow. A <b>BURN</b> or a <b>FIRE</b> caused by abnormal heating due to disturbed cooling is feared.</li> <li>• Fasten the foundation bolts surely. Insufficient fastening may cause an <b>INJURY</b> and <b>DAMAGE</b> due to shift of the Ring Blow.</li> <li>• Never get on or hang on the Ring Blow. An <b>INJURY</b> is feared.</li> <li>• Ring Blow shell be always mounted on suitable place in order to see its nameplate easily and do not put any obstacle in front of it. Do not dismount the nameplate.</li> </ul>
Piping, Wiring	<ul style="list-style-type: none"> <li>• Construct the piping and wiring according to the technical standard for electrical equipment and the internal wiring provisions. A <b>BURNOUT</b> or a <b>FIRE</b> is feared.</li> <li>• For wiring to the terminal base in terminal box, fasten the terminal screws with a torque of 1.0 to 1.3 N · m. Otherwise, <b>DAMAGE</b> of the terminal box is feared.</li> <li>• For measuring the insulation resistance, do not touch the terminal. An <b>ELECTRIC SHOCK</b> is feared.</li> <li>• No protection unit belongs to the Ring Blow except for some models. The installing of overcurrent protection unit is obliged based upon the technical standard for electrical equipment. For preventing a <b>FIRE</b> and <b>DAMAGE</b> due to a motor burnout, we recommend to install the protection unit other than overcurrent protection units (including a ground fault interrupter) based upon consulting with us.</li> </ul>
Operation	<ul style="list-style-type: none"> <li>• If any abnormality occurs, stop the operation immediately and switch off the power supply. An <b>ELECTRIC SHOCK</b> an <b>INJURY</b> or a <b>FIRE</b> is feared.</li> <li>• The Ring Blow becomes considerably hot during its operation. Take care not to touch it by your hand or body. A <b>BURN</b> is feared.</li> <li>• Do not insert your finger or any others material into the opening of Ring Blow. An <b>ELECTRIC SHOCK</b> an <b>INJURY</b> or <b>FIRE</b> is feared.</li> <li>• Wear stopples during operation to shut the big noise.</li> </ul>



## Caution

Maintenance , Inspection	<ul style="list-style-type: none"><li>• Do not touch the terminal for measuring the insulation resistance. An <b>ELECTRIC SHOCK</b> is feared.</li><li>• The Ring Blow becomes considerably hot during its operation. Take care not to touch by your finger and body. A <b>BURN</b> is feared.</li><li>• Take care, if you use a solvent or the like for cleaning the Ring Blow. A <b>POISONING</b> is feared. Further, the use of thinner or benzene may cause discoloring or exfoliation of coating on the Ring Blow.</li></ul>
Disassembly, Repair, Modification	<ul style="list-style-type: none"><li>• The repair, disassembling and modification shall be executed only by experts. An <b>INJURY</b> due to the edge of Impeller or key groove, an <b>ELECTRIC SHOCK</b> or a <b>FIRE</b> is feared.</li></ul>
Disposal	<ul style="list-style-type: none"><li>• Handle the Ring Blow as a general industrial waste, when it is be disposed.</li></ul>

## Package Opening and Product Verification

When the Ring Blow has been delivered, verify the following points.



## Caution

- |  |   |
|--|---|
|  | 1. Verify the top and the bottom of product and open the package. Otherwise, an <b>INJURY</b> is feared.  |
|  | 2. Open the wooden frame package taking care of the used nails. Wear glove when opening the wooden package. An <b>INJURY</b> is feared.   |
|  | 3. Verify if the delivered product is just the ordered one. (Check the output voltage, frequency, model etc. with the description on face plate.) An <b>INJURY</b> , <b>DAMAGE</b> or a <b>FIRE</b> is feared, if an incorrect product is used. |
|  | 4. Verify if any part is damaged and if any bolt or nut is loosened during the transport.   |

## Transport

Take care of the following points for transporting the Ring Blow.



### Caution



1. Take full care of fall and tumbling down during transportation. An **INJURY** is feared.
2. Lift up the Ring Blow equipped with a hanger bolt always after getting rid of loosening of the hanger bolt. But after mounting the Ring Blow on a machine, do not lift up the entire machine using the mounted hanger bolt.  
Verify the mass of motor based in the nameplate, package box, outline drawing, catalog or the like before lifting it and do not lift any more mass than the rated load of lifting tool. The gravity center of the Ring Blow is located at motor side, therefore, the Ring Blow inclines to one side during lift-up.  
Exert tension gradually on the wire and do not lift up suddenly.  
This lift-up work may only be executed by the qualified workers. Do not stay under the Ring Blow during the lifting work.  
An **INJURY** or **FIRE** caused by **FALL** or **TUMBLING DOWN** is feared for all of these cases.
3. Ambient temperature should be kept  $-20^{\circ}\text{C} \sim +60^{\circ}\text{C}$  during transportation.

### Lifting method of the Ring Blow

#### 1. Use one hanger bolt

(VFZ401~VFZ701)

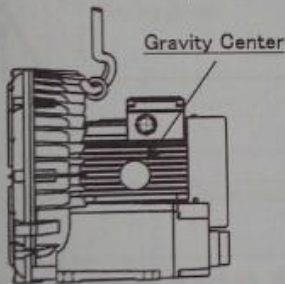

#### 2. Use two hanger bolts

(VFZ801, VFZ901)



#### In case of terminal box is located 45°

(VFZ801, VFZ901)

Move hanger bolt



## Safekeeping

Take care of following points for safekeeping the Ring Blow or suspending its operation for a long period.

1. For safekeeping in the packed.  
Keep the Ring Blow in an indoor dry place (Ambient temperature:  $-20^{\circ}\text{C} \sim +50^{\circ}\text{C}$ ). Do not keep it on such a place, as is exposed to water or dust, or with vibration, or place it on a bare ground directly.
2. For keeping it in the installed condition.
  - (a) Cover the entire Ring Blow with a sheet for protecting it from invasion of moisture foreign materials.
  - (b) Keep the Ring Blow with its hanger bolt mounted. If it is kept with the hanger bolt dismantled, water may sometimes invade into through the screw hole.
  - (c) Run the Ring Blow for some minutes keeping it and every 3 months, for protecting the bearings from rusting.
  - (d) If the operation of Ring Blow is suspended for a long period, measure the insulation resistance of its winding every 6 months and verify that it is kept at higher than 1 M $\Omega$ . If the resistance is not higher than 1 M $\Omega$  at normal temperature, such measures are required as to dry the winding.
  - (e) Keep the Ring Blow in an indoor dry place (Ambient temperature:  $-20^{\circ}\text{C} \sim +50^{\circ}\text{C}$ ).

## Name of parts

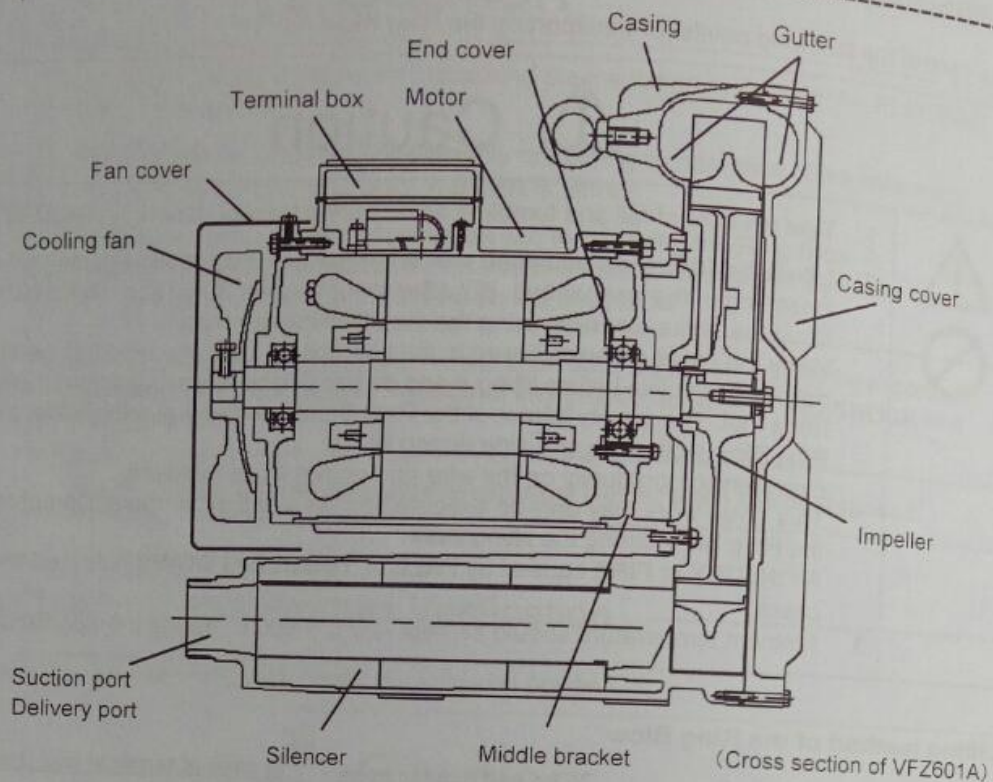

## Installation and Piping

- 1 Take care of the following points for installing and adjusting the Ring Blow.

### Alarm



1. Ground the protective earthing terminal surely.  
An **ELECTRIC SHOCK** or a **FIRE** is feared.



2. In case of using the Ring Blow mounted on a ceiling or wall, its fall is feared depending upon the condition. Follow the catalog or instruction manual for details of usable range.  
**INJURY** caused by its **FALL** is feared.

### Caution



3. Never place any inflammable object around the Ring Blow.  
A **FIRE** is feared.



4. Do not place any obstacle, which disturbs the ventilation, around the Ring Blow.  
A **BURN** or a **FIRE** caused by abnormal heating are feared, due to the disturbed ventilation.



5. Fasten the foundation bolts surely before starting the operation. An **INJURY** or **DAMAGE** due to shift of the Ring Blow is feared, if the fastening is insufficient.



6. Never step on or hang from the Ring Blow  
An **INJURY** is feared.











7. Make the nameplate for the Ring Blow always easily legible and do not place any obstacle in front of it. Do not dismount the face plate.

2 Take care of the following ranges for the installation site and the gas to be transported.



## Caution

	1. Outdoor/indoor:	Install at an indoor site, which is exposed to no wind and rain. Otherwise, an <b>ELECTRIC SHOCK</b> or a <b>FAULT</b> is feared.
	2. Ambient temp./ transport gas:	Use it in the range from -10 to 40°C. Otherwise, shortening of life and a <b>FAULT</b> is feared. (No freezing is allowed.)
	3. Relative humidity / altitude:	Use relative humidity in 80% or less and 1000m above sea level or less. Shortening of life or <b>FAULT</b> is feared.
	4. Atmosphere / gas to be transported:	If can neither be used in a place, where any such corrosive liquid or gas as an acid or an alkali or any inflammable or explosive gas exists, nor transport such material. A <b>FIRE</b> , a <b>FAULT</b> or a <b>INJURY</b> is feared.
	5. Dusts:	Evade a place, where a lot of dusts, wastes or thread chips exist. If inevitable, clean the dusts and wastes adhered in the blower regularly. A <b>FIRE</b> or a <b>FAULT</b> is feared.
	6. Ventilation:	Select a well ventilated place. It shall not be used in a closed room or in a case. A <b>FIRE</b> , a <b>BURN</b> or a <b>FAULT</b> is feared.
	7. Ambient air:	Evade a narrow place, for the convenience of maintenance and inspection.
	8. Vibration:	Select a place, where no external vibration is added to the blower. If inevitable, take anti-vibration measures for protecting from addition of vibration the blower. A <b>FAULT</b> , <b>DAMAGE</b> or an <b>INJURY</b> is feared. The value in Figure 1 is recommended as the tolerable vibration value.

Size and tightening torque (recommendation value) of the anchor bolt

Anchor hole mm	Bolt size mm	Tightening torque N·m
$\phi$ 10	M8	11.7
$\phi$ 12	M10	23.4
$\phi$ 15	M12	41.3
$\phi$ 19	M16	105

※ Bolt materials are recommended values in case of SS, SWRM

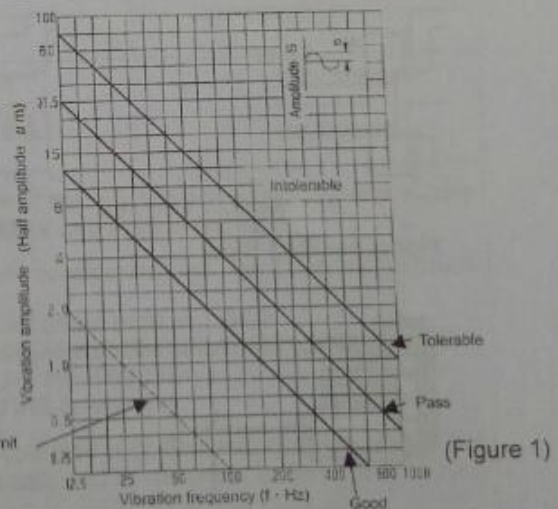

(Figure 1)

9. Install the Ring Blow so as to be used in horizontal shaft condition. For installing it in vertical or slant shaft condition, install it so that its blower side lies under its motor side (Figure 2).  
 ※VFZ701~VFZ901: Horizontal shaft condition only

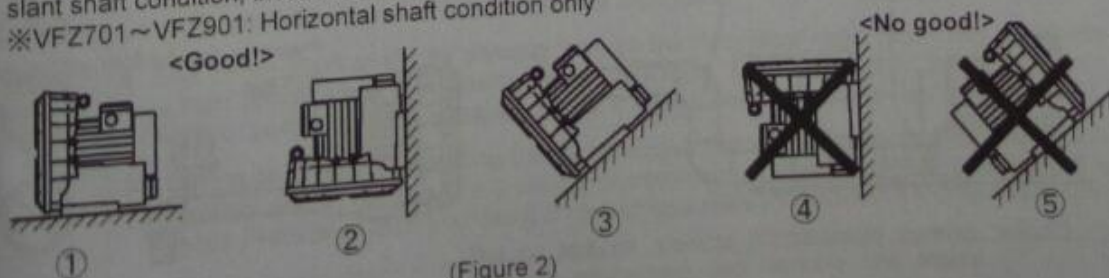

(Figure 2)



10. For using VFZ501 or VFZ601 in fully closed suction operation, dismount the emblem at the top of middle bracket before installation. Dismount the emblem on the middle bracket surely before installation of the body.

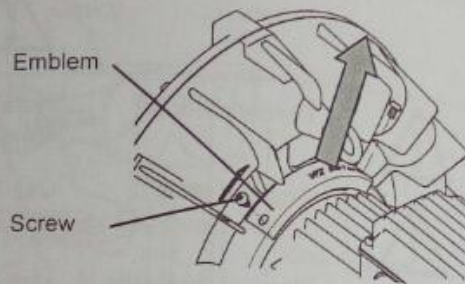

11. The tone quality of blower noise in this product changes depending on the Air flow rate, pressure and fully closed suction operation.

12. Use such pipes as PVC-pipes, gas pipes, flexible hoses etc., which can hold the Ring Blow pressure and hoses other than metallic one for discharge side, use those once, which have a sufficient high-temperature resistance.

Lay piping so surely as to have no leakage (Figure 3).

### Kind of piping for suction port and delivery port.

Type exclusively used for house  
(Type from VFZ101A to VFZ301A)

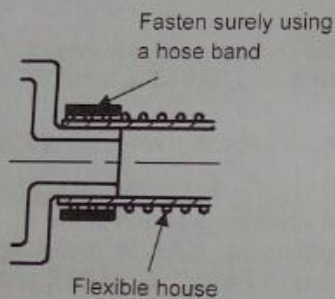

Type for house and screwed pipes (Type from VFZ401A to VFZ601A)

In case of flexible house

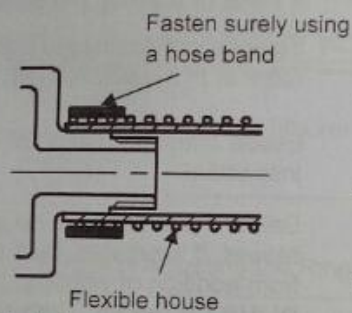

In case of screwed pipes

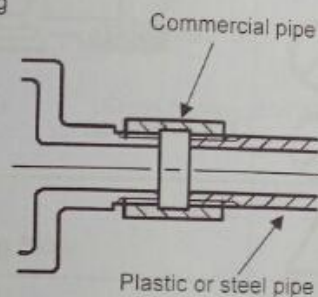

Type for companion flanges  
(Type from VFZ101AF to VFZ601AF)

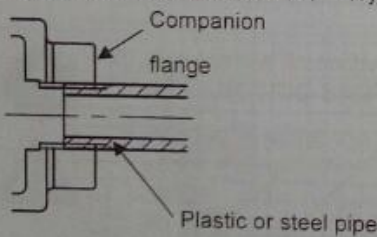

Type exclusively used for screw pipes  
(Type from VFZ701 to VFZ901)

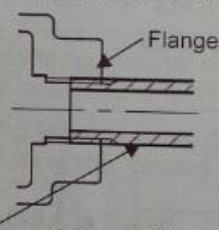

※ In case of piping to companion flanges, companion flanges must be removed from the Ring Blow before piping, it should be assembled after piping. Take care of the breakage by tightening pipes too much.

### Piping for Ring Blow

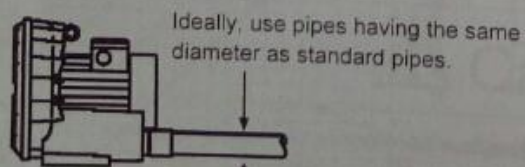

Use large diameter pipes for long piping having many bends

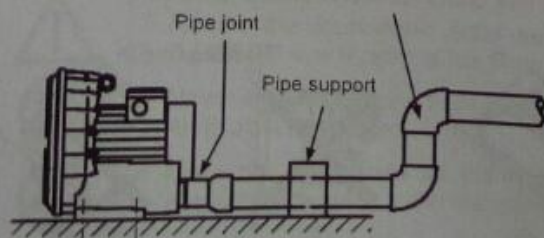
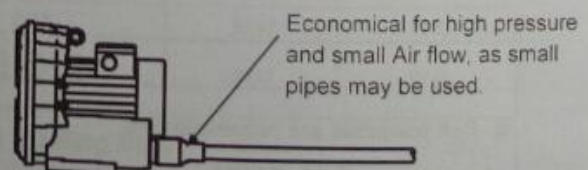

Caution: Arrange pipe-supports properly, so that no self weight and external load concentrate on pipe connections.

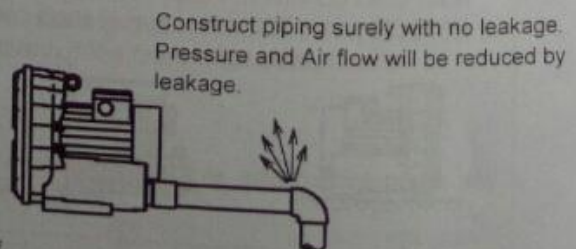





(Figure 3)









13. Do not allow any foreign material to intrude into the blower.
14. The rotation direction shall be the arrow direction on the casing. The rotation direction can be seen at the shaft end at counter-blower side and it is also correct, if the wind direction coincides with the IN and OUT indicated at the pipe connection port. Reverse rotation is allowed, although the performance is reduced.
15. Connect the power cables by using gland or electrical conduit at wiring hole of the terminal box to protect dust, foreign objects, water and etc. into the terminal box inside. Do not remove the unused rubber bushes of VFZ501~VFZ901. Do not use the rubber bushes to wiring.
16. Take care of edge of wiring holes at the terminal box. An **INJURY** is feared.

Recommended gland VFZ101~VFZ701: Multi hole type seal connector  
VFZ801, VFZ901: Seal connector

## Operation -----

Verify the following points for operating the Ring Blow.

 <b>Alarm</b>	
  	<ol style="list-style-type: none"> <li>1. Never access or touch the rotating body (cooling fan etc.) during running. <b>CATCH-IN</b> or <b>INJURY</b> is feared.</li> <li>2. Turn the power supply switch off in case of power failure. <b>INJURY</b> is feared, when the machine runs suddenly at the power restoration.</li> <li>3. Be sure to turn the power supply switch off, in the Ring Blow has been stopped because the attached protection unit has been activated. An <b>INJURY</b> is feared, as the machine may run suddenly at the power restoration.</li> </ol>

 <b>Alarm</b>	
      	<ol style="list-style-type: none"> <li>4. If any abnormality occurs, stop the operation immediately and turn the power supply switch off. An <b>ELECTRIC SHOCK</b>, an <b>INJURY</b> or a <b>FIRE</b> is feared.</li> <li>5. During operation the Ring Blow, it becomes considerably hot. Take care not to touch by your hand or body. A <b>BURN</b> is feared.</li> <li>6. During its operation, do not insert your finger or any other object into the opening (fan cover, admission and discharge ports etc.) of the Ring Blow. An <b>ELECTRIC SHOCK</b>, an <b>INJURY</b> or a <b>FIRE</b> is feared.</li> <li>7. If the Ring Blow (VFZ401A and larger) is operated with the discharge side closed, the motor and blower temperature rises drastically and its distortion or damage after long time operation is feared.</li> <li>8. If the Ring Blow is operated at a wind flow rate not more then continuous operation range, the motor and blower temperature rises drastically and its distortion or damage is feared, if the operation is continued for along time.</li> <li>9. The temperature of the air passing through the Ring Blow rises. Especially it reaches a high temperature at a nearly closed condition. Take care not to touch it by your hand or body. A <b>BURN</b> is feared. Figure 6 shows the temperature rise.</li> <li>10. During its operation, the Ring Blow and discharged air will reach a considerably high temperature. Do not use it in a narrow closed room. A <b>BURN</b>, a <b>FIRE</b> or <b>DAMAGE</b> is feared. (Inquire of us, if you use it in closed operation.)</li> </ol>

11. The Ring Blow will be continuously at within the operation range shown on the wind flow rate to static pressure curve (shown in the catalog). This operation range is so wide that the machine can be operated at nearly closed pressure but, if you operate it at high pressure, especially take care not to exceed the operation range. If you must operate it at closed condition, arrange a bypass hole on the way, so that a more wind than required range flows through the blower even if the suction port is closes (Figure 4).

For using VFZ401A-VFZ601A with the discharge side closed

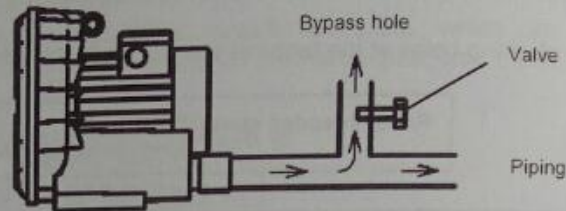

(Figure 4)

12. For using air intermittently, the switching by means of a valve is recommended rather than the switching on and off of the motor (Figure 5). The standard for start and stop frequency of Ring Blow shall be not higher than the values in table below.

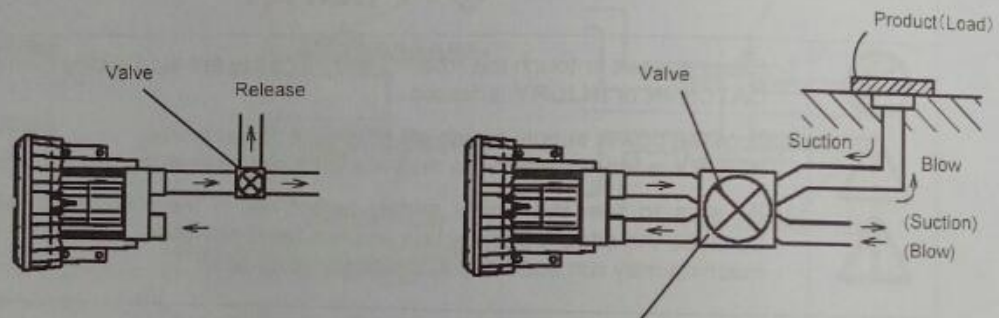

(Figure 5)

Switch suction and blow using the valve.

Tolerable start/stop frequency for Ring Blow [Sw/Hr]	
Model	Value for frequency of 50/60Hz
VFZ101 - VFZ301	30/20
VFZ401 - VFZ601	20/15
VFZ701 - VFZ901	15/10

\*1 switch: one cycle of ON and OFF

13. The characteristics differ a little when the machine is used at suction side and when used at discharge side, as shown in the characteristics curve. As the air specific weight becomes larger, when the discharge side is throttled, the static pressure becomes also larger.
14. Remove any solid object, dust, thread chip, water drop or the like before entering into the Ring Blow. Even if make no dust be sucked directly, take measures not to suck any dust staying around by mistake. Use of the dust collection sack in a vacuum cleaner or the like is recommended. Also, it is recommended to use a filter having considerably large space. Remove sometimes the dust collected in the filter. It may also be possible to make the dust blow off by reversing the Ring Blow, if it is possible.
15. If dusts adhered inside and outside of the blower (especially in the cooling air path for cooling fan cover), remove them. If adhered dusts increase, it causes such troubles as a temperature rise, a sink of wind flow rate and an increase vibration.
16. As the motor load (current) changes depending upon the air flow used by the Ring Blow, refer to the characteristics curve for setting the wiring capacity and protection relay.

17. The bearing, oil seal and silencer are consumables and need to be changed when their lives are arrived. Depending on the environment, in which the machine was used, the Impeller, casing, casing cover, and wire net are also included in consumables. (Please notice delivery and suction material is different from VFZ50's and VFZ60's silencers when you exchange them.)

Intervals for inspection and exchange of consumables

Part name	Inspection/exchange interval
Bearing	2 years
Oil seal	At the same time as bearings
Silencer	2 years

\*Standard for use in a standard environment.  
They may be shorter depending on the environment.

Table of bearing and oil seal

Model	Bearing		Grease	Oil seal	
	Load side	No-load side		Model	Material
VFZ081PN	6201ZZ	6201ZZ	Urea	-	-
VFZ101PN	6202ZZ	6202ZZ	Urea	VCH20-30-5	Nitrile rubber
VFZ201PN	6202ZZ	6202ZZ	Urea	SC20-30-7	Nitrile rubber
VFZ301PN	6202ZZ	6202ZZ	Urea	SC20-30-7	Nitrile rubber
VFZ401PN	6204ZZ	6203ZZ	Urea	-	-
VFZ081A	6201ZZ	6201ZZ	Urea	-	-
VFZ101A	6202ZZ	6202ZZ	Urea	VCH20-30-5	Nitrile rubber
VFZ201A	6202ZZ	6202ZZ	Urea	SC20-30-7	Nitrile rubber
VFZ301A	6202ZZ	6202ZZ	Urea	SC20-30-7	Nitrile rubber
VFZ401A	6204ZZ	6203ZZ	Urea	-	-
VFZ501A	6206ZZC3	6303ZZ	Urea	-	-
VFZ601A	6206ZZC3	6205ZZ	Urea	-	-
VFZ701A	6306ZZC3	6206ZZ	Urea	-	-
VFZ801A	6308ZZC3	6207ZZ	Urea	-	-
VFZ901A	6308ZZC3	6306ZZ	Urea	-	-

※Common to VFZ-A, VFZ-AF, VFZ-AN, VFZ-A-4Z

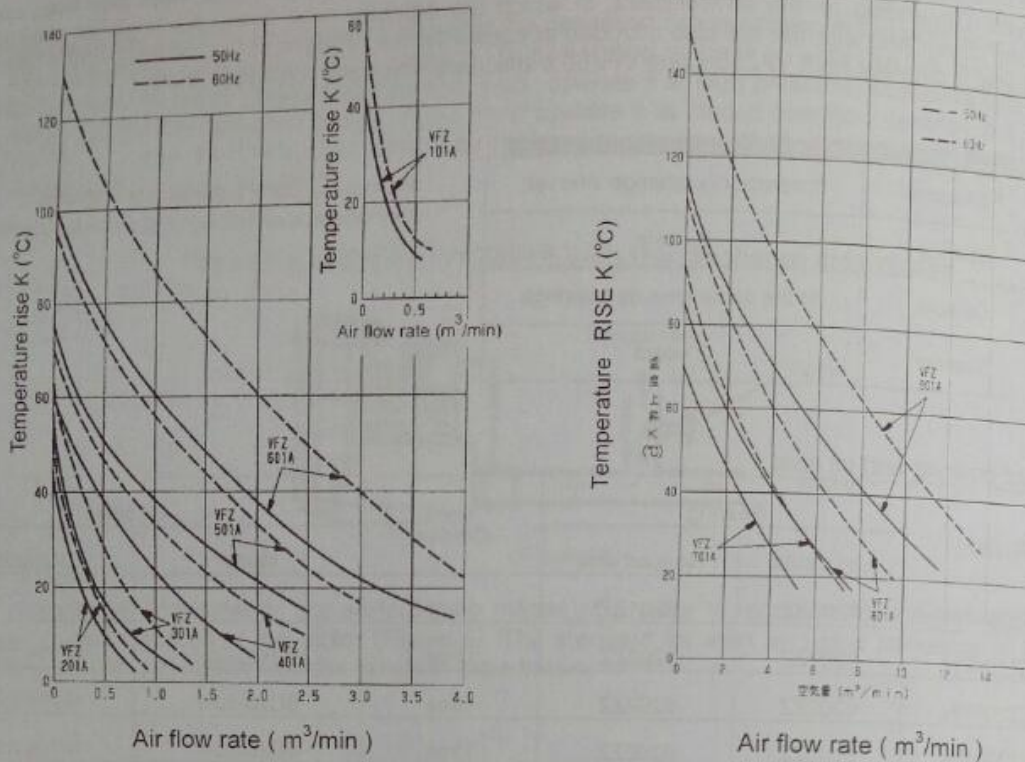

(Figure 6) Discharged air-temperature rise curve

18. Wire the power cables with motor terminals surely according to wiring figure in the terminal box or Figure 7.

(※Wiring type of VFZ801 and VFZ901 is direct start type at shipping, therefore, change wiring type from direct start type to star-delta start type in case of using star-delta start type.)

Model	VFZ101PN~VFZ401PN	VFZ101~VFZ701	VFZ801, VFZ901	
Wires	2 wires	3 wires	6 wires	
Connecting method	Motor terminal (U) (V) ↑ ↑ R S Power supply	Motor terminal (U) (V) (W) ↑ ↑ ↑ R S T Power supply	Direct start type (At shipping) Motor terminal (V2) (W2) (U2) (U1) (V1) (W1) ↑ ↑ ↑ R S T Power supply	Star-delta start type Motor terminal (V2) (U1) (W2) (V1) (U2) (W1) ↑ ↑ ↑ ↑ ↑ V2 U1 W2 V1 U2 W1 Power supply

(Figure 7) Wiring diagram

19. Confirm below items at test running, if inverter is applied for the Ring Blow operation.
- Resonance is feared by install condition of the Ring Blow. Avoid the frequency of the resonance
  - Vibration and noise become bigger by using inverter. Stop the operation immediately, if abnormal temperature rise or vibration occurs.
  - Do not use over 60Hz to protect motor burning.
- (Maximum frequency of the 50Hz exclusive model is 50Hz.)

## Faults and Countermeasures-----

In case of occurrence of any fault in the Ring Blow, handle it properly referring to Table 1 "Fault States of Ring Blow and Countermeasures" (page 12) and taking care of the following points.



### Caution



1. Always only the expert shall investigate, repair, disassemble and modify the fault. An **INJURY** due to the Impeller edge or key groove, an **ELCTRIC SHOCK** or a **FIRE** is feared.



2. If the Ring Blow must be abandoned as the result of investigation in a rare possibility, dispose it as a general industrial waste.

3. If the investigation result shows that the machine cannot be easily repaired, if you will request any spare part or you have any trouble, contact our agent, dealer or business office at any time. In case of contacting us, please verify following items in advance:

- (a) Model indicated in the nameplate,
- (b) SER. No.,
- (c) Details of the fault,
- (d) Name of faulty part, name of spare parts,
- (e) Required quantity and
- (f) Kind of gas to be transported (e.g. Air)

Table - 1 Fault States of Ring Blow and Countermeasures

States of Fault		Causes	Countermeasures
Does not rotate	Whining sound	Switch-contact fault	Repair switch-contact.
		Fuse blown	Replace it.
		One phase of power supply connection wires disconnected.	Replace it.
		One phase of stator coils disconnected.	Request factory to repair it.
		Stator and rotor come into contact due to bearing fault.	Replace bearing.
		Foreign material involved in blades.	Remove it.
	No sound	Power failure	Consult with utility company.
		2 phases of power supply connection wires disconnected.	Replace them.
		2 phases of stator coils disconnected.	Request factory to repair them.
		Switch fault	Replace or replace it.
Rotates	Fuse blown	Insufficient fuse capacity	Replace it with larger capacity.
		Short-circuit in circuit	Repair or replace it.
	Motor overheated	Power supply voltage fell	Consult with utility company.
		Single phase operation	Request factory to repair it.
		Impeller rubbing	Adjust wheel.
	Whining sound	1 phase short circuit in stator coils.	Request factory to repair it.
		Uneven space between stator and rotor.	Request factory to repair it.
	Abnormal noise	Blade wheel rubbing	Adjust it.
		Blade damaged due to foreign material.	Request factory to repair it.
		Bearing fault	Replace it.
	Motor rotates but fan works improperly.	Leakage in piping.	Fasten tightly.
		Piping blocked	Ventilate sufficiently.
		Reverse rotation direction	Correct connection (2 out of 3 wires).
		Closure equipment fault	Replace it.

## Parts List and Disassembled Drawings -----

The Parts List of Ring Blow is shown below.

The Parts No. in Parts List corresponds to those in Disassembled Drawings.

Caution: Some parts are not used for some machine models.

Part No.	Name of Part	Part No.	Name of Part	Part No.	Name of Part
1-1	Casing cover	3-6	Spacer	4-17	Bolt (Middle bracket, frame)
1-2	Bolt (for Casing cover)	3-7	Press ring	4-18	Spring washer
1-3	Impeller	3-8	Bolt (for fastening Fan wheel)	4-28	Cap
2-1	Casing	3-9	Claw washer	5-1	Terminal box
2-2	Bolt (for Casing)	3-11	Key (for Fan Wheel)	5-2	Packing (for Terminal box)
2-3	Spring washer	3-12	Motor cooler fan	5-3	Terminal box cover
2-4	End cover	3-13	Bolt (for Motor cooler fan)	5-4	Bolt (for Terminal box )
2-5	Bolt (for End cover)	3-15	Collar	5-5	Bolt (for Terminal box conduction)
2-6	Spring washer	3-22	Emblem	5-6	Packing (for Terminal box cover)
2-7	Silencer (1 set)	3-23	Bolt (for Emblem)	5-7	Bolt (for Terminal box cover)
2-7-1	Silencer (Suction side)	4-1	Frame/Stator assembly	5-8	Bush (for Terminal box)
2-7-2	Silencer (Delivery side)	4-4	Shield at counter-driving side	5-9	Bolt (for Protective earthing terminal)
2-8	Flange	4-5	Waved washer	5-10	Terminal base
2-9	Bolt (for Flange)	4-7	Bolt (for Shield)	5-11	Bolt (for Terminal base)
2-14	Oil seal	4-8	Cooler fan cover	5-12	Spring washer
2-15	Silencer Retaining Net	4-9	Bolt (for Cooler fan cover)	5-18	Base plate (for Terminal base)
2-18	Hanger bolt	4-13	Bolt (Shield, frame)	5-20	Bush (for Leader mouth for Terminal box)
3-1	Shaft/Rotor assembly	4-14	Nut (Shield, frame)	9-1	Nameplate (Rating)
3-4	Bearing at counter-driving side	4-15	Spring washer (Shield, frame)	9-2	Nameplate (Caution)
3-5	Bearing at driving side	4-16	Middle bracket	9-3	Nameplate (PSE mark)



**Disassembled VFZ101A - VFZ301A**

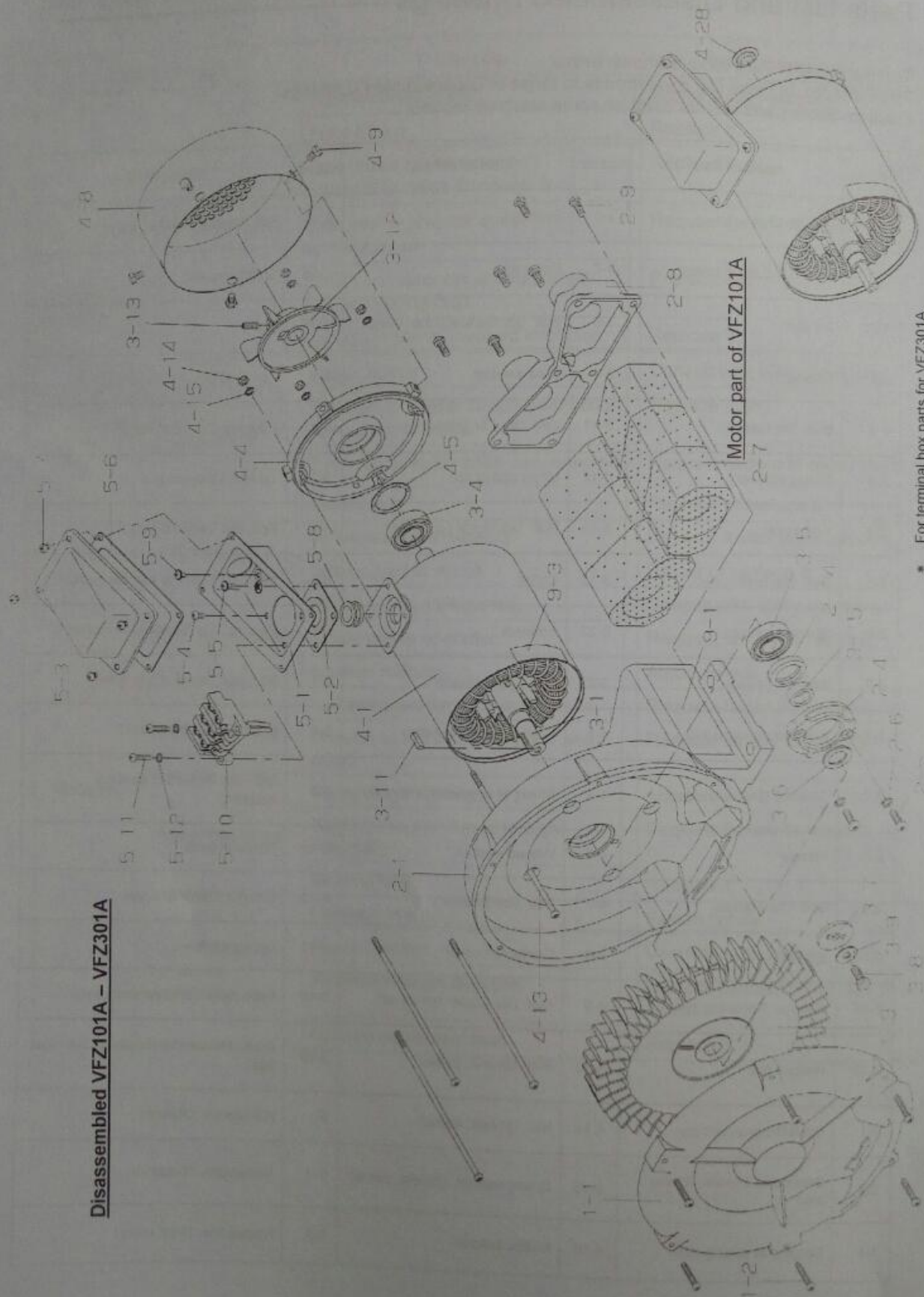

- \* For terminal box parts for VFZ301A.
- \* See disassembled drawings of VFZ401A

Disassembled VFZ401A

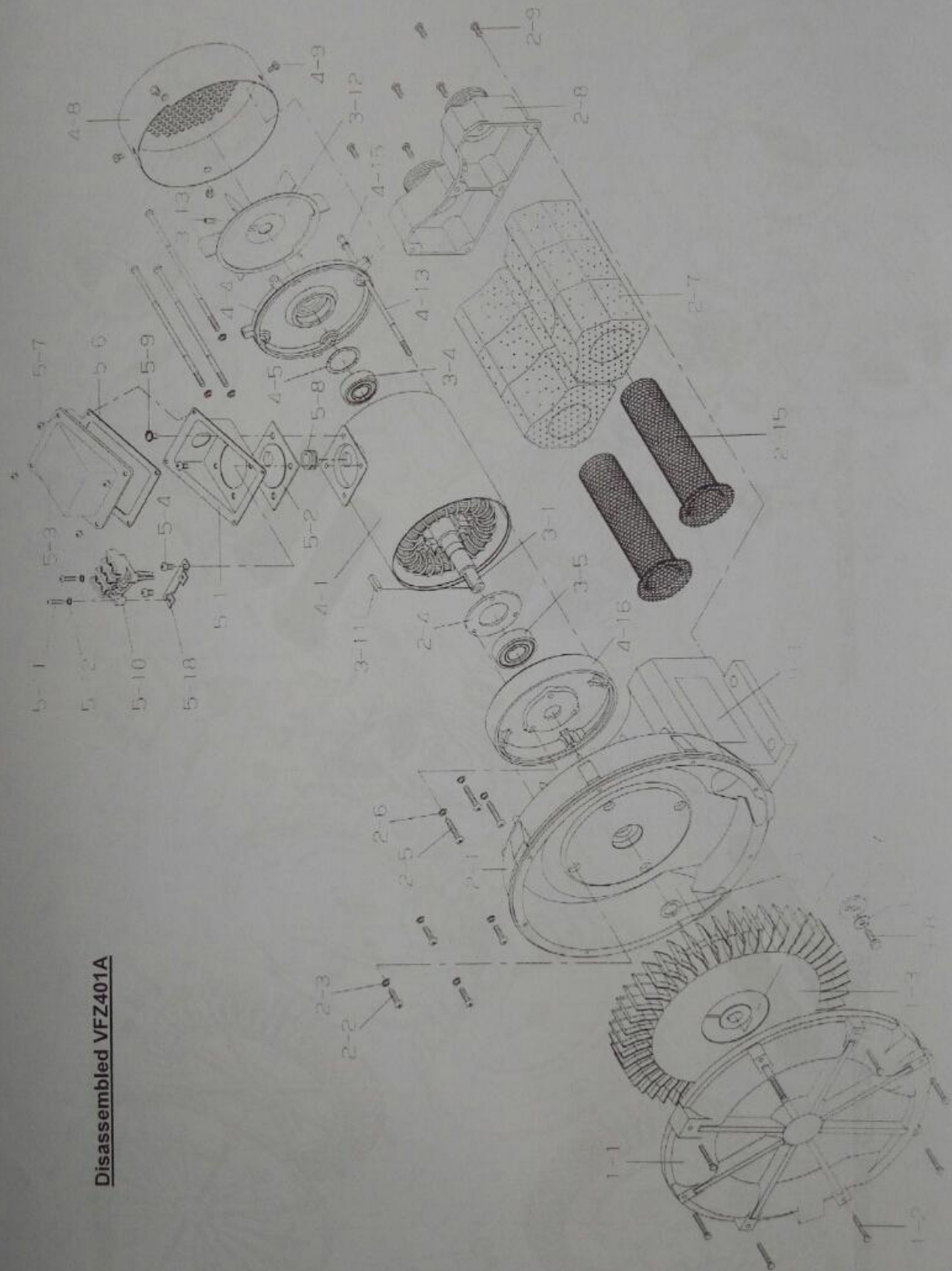

Disassembled VFZ501A ~ VFZ601A

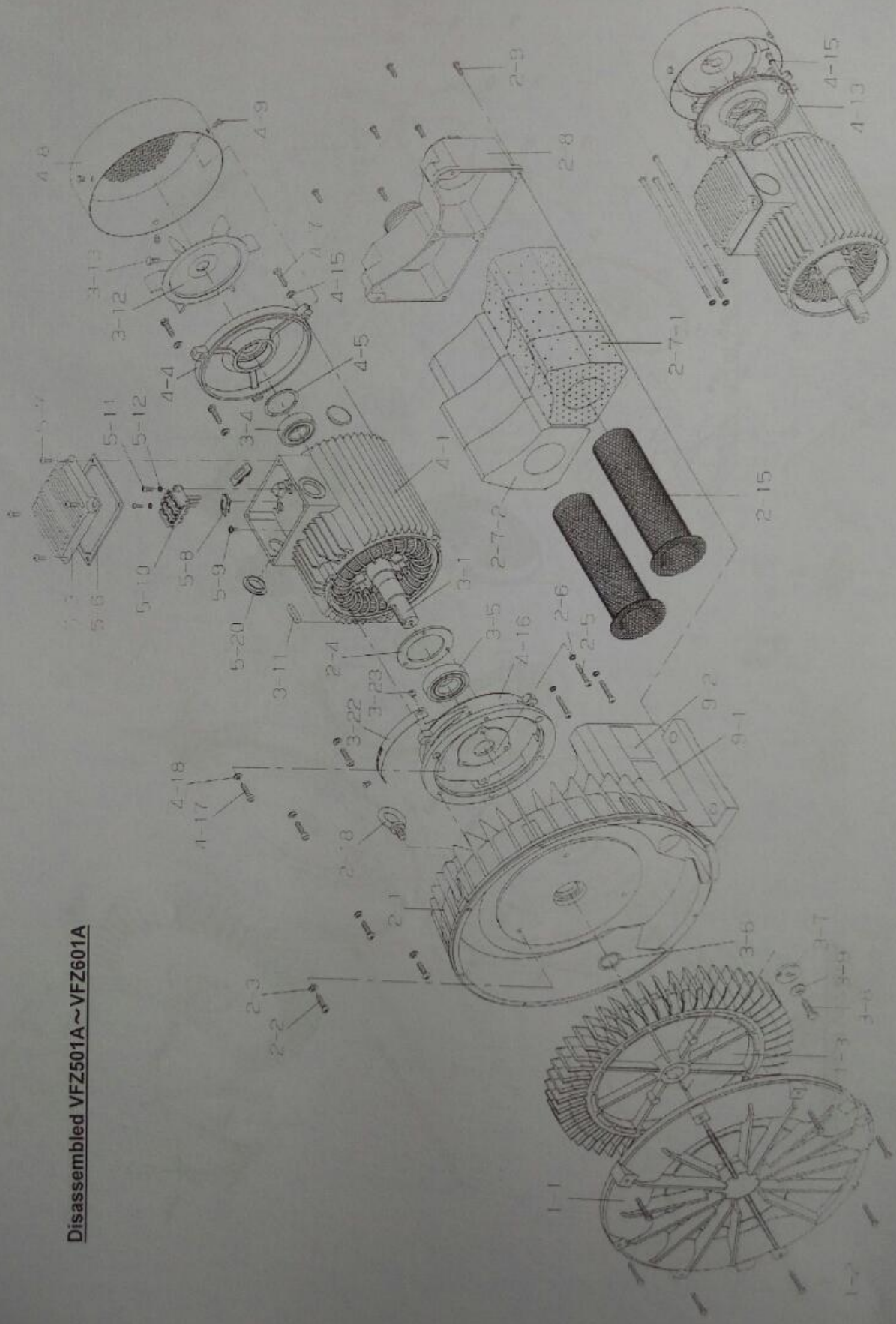

Disassembled VFZ701A~VFZ901A

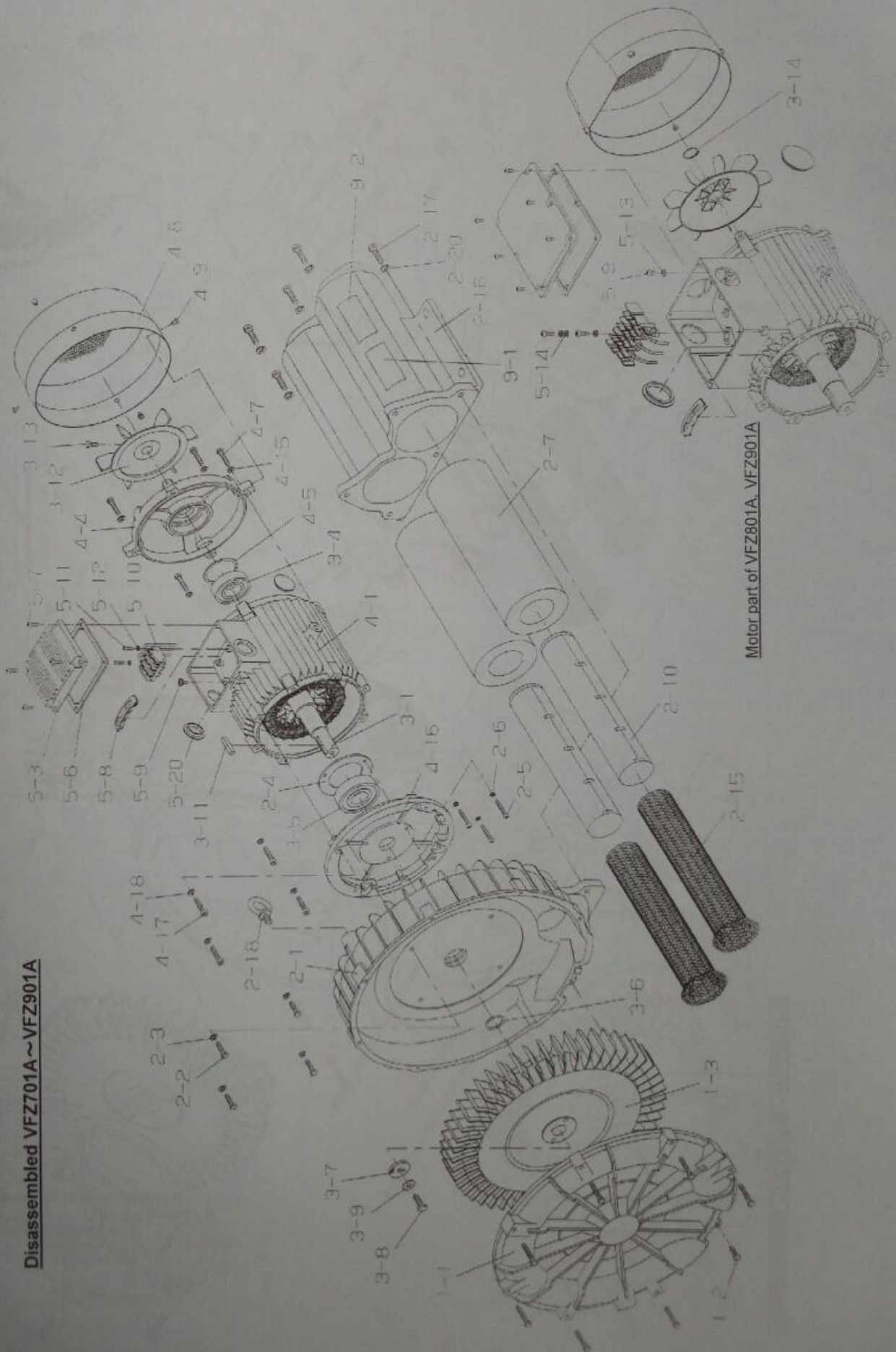

Motor part of VFZ801A, VFZ901A

**Disassembled VFZ101PN~VFZ301PN**

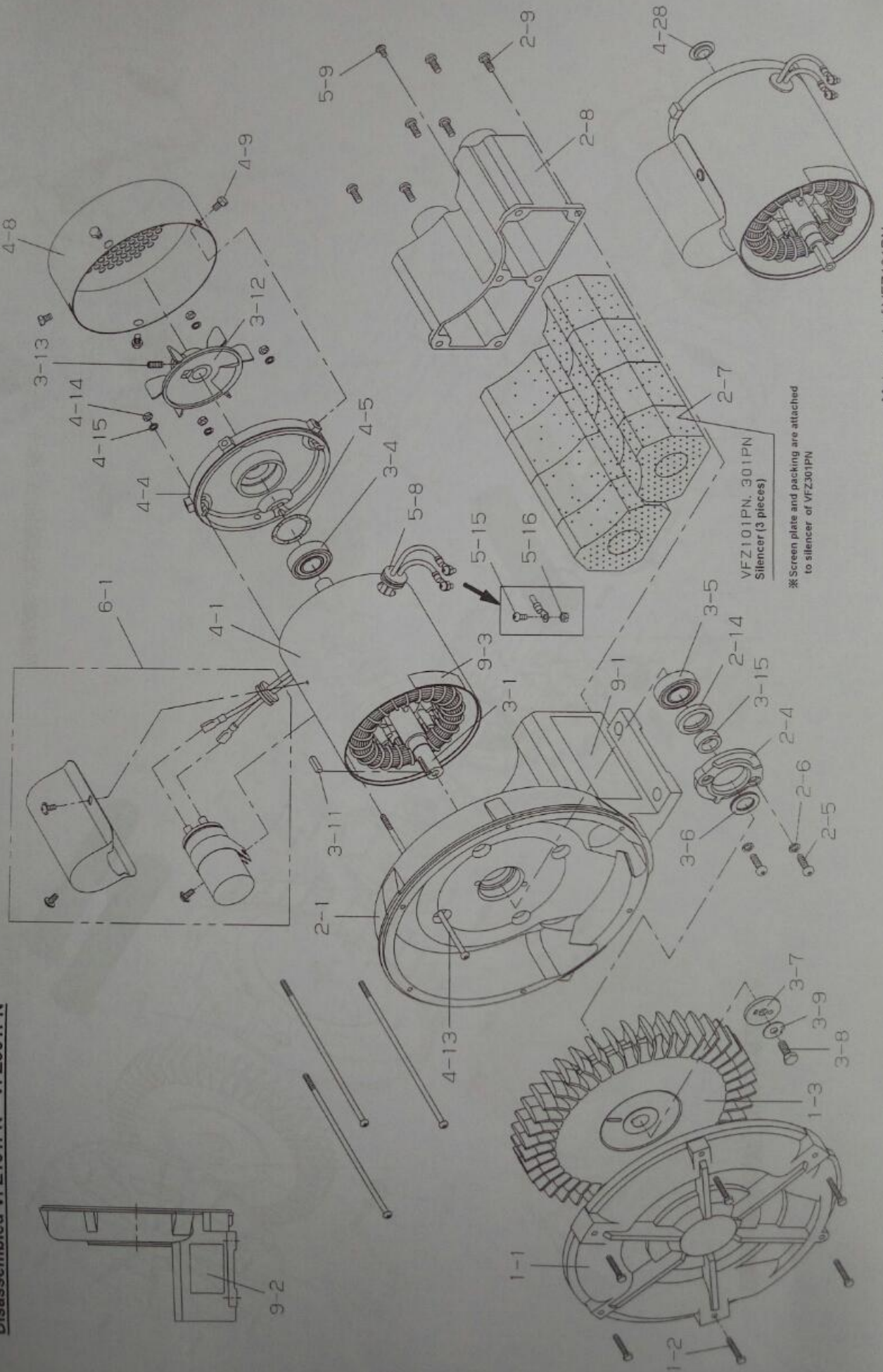

Motor part of VFZ101PN

**Disassembled VFZ401PN**

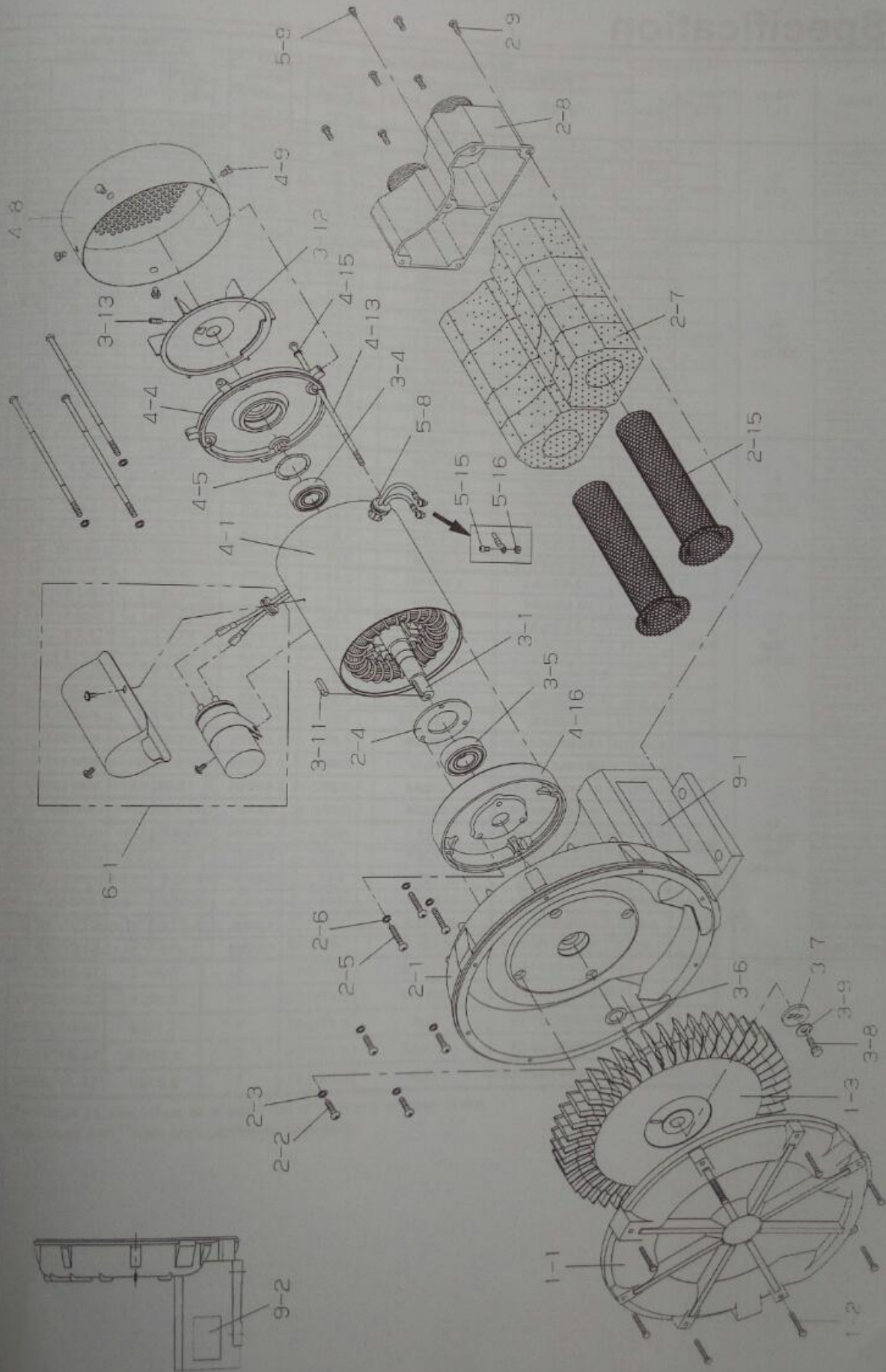

# Specification

Model	Voltage [V]	Frequency [Hz]	Delivery character					Suction character		
			Maximum value			Rated value		Maximum Value		
			Output <sup>(1)</sup> [kW]	Current <sup>(1)</sup> [A]	Static pressure [kPa]	Static pressure <sup>(2)</sup> [kPa]	Delivery air quantity <sup>(1)</sup> [m <sup>3</sup> /min]	Output [kW]	Current [A]	Static pressure [kPa]
VFZ081PN	1φ 100/ 100-110	50/60	0.05/0.08	1.3/1.4-1.3	3.73/4.85	1.96	0.25/0.35	0.05/0.07	1.2/1.3-1.3	3.43/4.60
VFZ101PN			0.09/0.12	1.5/2.0-1.9	5.10/6.86	2.94	0.35/0.50	0.08/0.10	1.5/1.8-1.7	4.91/6.55
VFZ201PN			0.17/0.28	4.5/4.4-4.2	6.67/8.63	2.94	0.64/0.84	0.17/0.25	4.3/4.2-4.1	6.05/7.85
VFZ301PN			0.25/0.38	5.0/5.8-5.6	9.61/12.0	3.92	0.9/1.1	0.25/0.38	5.0/5.8-5.6	8.8/11.2
VFZ401PN			0.50/0.75	7.0/11.0-10.0	9.81/13.2	4.90	1.45/1.95	0.48/0.70	7.0/11.0-10.0	9.36/12.3
VFZ081A	3φ 200/ 200-220	50/60	0.06/0.08	0.37/0.42-0.40	3.73/4.85	1.96	0.25/0.35	0.06/0.08	0.37/0.42-0.40	3.43/4.60
VFZ101A			0.09/0.12	0.52/0.64-0.62	5.15/6.37	2.94	0.35/0.50	0.09/0.12	0.52/0.64-0.62	4.90/6.21
VFZ201A			0.17/0.28	1.4/1.4-1.4	6.67/9.02	2.94	0.64/0.84	0.17/0.28	1.4/1.4-1.4	6.27/8.19
VFZ301A			0.28/0.42	1.8/1.9-1.8	9.32/12.4	3.92	0.9/1.1	0.28/0.42	1.8/1.9-1.8	8.73/11.4
VFZ401A			0.55/0.85	3.1/3.7-3.6	10.4/14.1	4.90	1.45/1.95	0.53/0.83	3.0/3.5-3.4	9.4/12.9
VFZ501A			1.3/1.9	5.4/7.4-6.8	14.7/19.6	6.86	2.4/3.0	1.3/1.9	5.4/7.4-6.8	13.7/17.3
VFZ601A			2.3/3.4	11.5/13.0-12.5	21.1/27.5	9.81	3.2/4.4	2.3/3.4	11.5/13.0-12.5	18.2/23.6
VFZ701A			3.3/5.0	16/20-19	21.6/28.4	9.81	4.4/5.7	3.1/5.4	14/19-18	18.3/22.9
VFZ801A			5.0/7.0	21/28-26	25.5/33.3	9.81	6.3/8.5	5.2/7.6	20/30-28	21.6/26.6
VFZ901A			7.0/11.0	31/40-38	25.5/31.4	14.7	7.5/10.8	7.0/13	30/41-40	21.4/27.6
VFZ101AF			3φ 200/ 200-220	50/60	0.09/0.12	0.52/0.64-0.62	5.15/6.37	2.94	0.35/0.50	0.09/0.12
VFZ201AF	0.17/0.28	1.4/1.4-1.4			6.67/9.02	2.94	0.64/0.84	0.17/0.28	1.4/1.4-1.4	6.27/8.19
VFZ301AF	0.28/0.42	1.8/1.9-1.8			9.32/12.4	3.92	0.9/1.1	0.28/0.42	1.8/1.9-1.8	8.73/11.4
VFZ401AF	0.55/0.85	3.1/3.7-3.6			10.4/14.1	4.90	1.45/1.95	0.53/0.83	3.0/3.5-3.4	9.4/12.9
VFZ501AF	1.3/1.9	5.4/7.4-6.8			14.7/19.6	6.86	2.4/3.0	1.3/1.9	5.4/7.4-6.8	13.7/17.3
VFZ601AF	2.3/3.4	11.5/13.0-12.5			21.1/27.5	9.81	3.2/4.4	2.3/3.4	11.5/13.0-12.5	18.2/23.6
VFZ701AF	3.3/5.0	16/20-19			21.6/28.4	9.81	4.4/5.7	3.1/5.4	14/19-18	18.3/22.9
VFZ101AN	3φ 200/ 200-220	50/60	0.09/0.12	0.52/0.64-0.62	5.15/6.37	2.94	0.35/0.50	0.09/0.12	0.52/0.64-0.62	4.90/6.21
VFZ201AN			0.17/0.28	1.4/1.4-1.4	6.67/9.02	2.94	0.64/0.84	0.17/0.28	1.4/1.4-1.4	6.27/8.19
VFZ301AN			0.28/0.42	1.8/1.9-1.8	9.32/12.4	3.92	0.9/1.1	0.28/0.42	1.8/1.9-1.8	8.73/11.4
VFZ401AN			0.55/0.85	3.1/3.7-3.6	10.4/14.1	4.90	1.45/1.95	0.53/0.83	3.0/3.5-3.4	9.4/12.9
VFZ501AN			1.3/1.9	5.4/7.4-6.8	14.7/19.6	6.86	2.4/3.0	1.3/1.9	5.4/7.4-6.8	13.7/17.3
VFZ601AN			2.3/3.4	11.5/13.0-12.5	21.1/27.5	9.81	3.2/4.4	2.3/3.4	11.5/13.0-12.5	18.2/23.6
VFZ701AN			3.3/5.0	16/20-19	21.6/28.4	9.81	4.4/5.7	3.1/5.4	14/19-18	18.3/22.9
VFZ801AN			5.0/7.0	21/28-26	25.5/33.3	9.81	6.3/8.5	5.2/7.6	20/30-28	21.6/26.6
VFZ901AN			7.0/11.0	31/40-38	25.5/31.4	14.7	7.5/10.8	7.0/13	30/41-40	21.4/27.6
VFZ081A-4Z			3φ 380-400- 415/ 400-440	50/60	0.06/0.08	0.2-0.2-0.21/0.22-0.21	3.73/4.85	1.96	0.25/0.35	0.06/0.08
VFZ101A-4Z	0.09/0.12	0.26-0.26-0.27/0.31-0.3			5.15/6.37	2.94	0.35/0.50	0.09/0.12	0.26-0.26-0.27/0.31-0.3	4.90/6.21
VFZ201A-4Z	0.17/0.28	0.6-0.63-0.66/0.7-0.68			6.67/9.02	2.94	0.64/0.84	0.17/0.28	0.6-0.63-0.66/0.7-0.68	6.27/8.19
VFZ301A-4Z	0.28/0.42	0.86-0.9-0.95/0.95-0.9			9.32/12.4	3.92	0.9/1.1	0.28/0.42	0.86-0.9-0.95/0.95-0.9	8.73/11.4
VFZ401A-4Z	0.55/0.85	1.7-1.6-1.5/1.9-1.8			10.4/14.1	4.90	1.45/1.95	0.53/0.83	1.7-1.6-1.5/1.9-1.8	9.4/12.9
VFZ501A-4Z	1.3/1.9	2.6-2.7-2.8/3.7-3.4			14.7/19.6	6.86	2.4/3.0	1.3/1.9	2.6-2.7-2.8/3.7-3.4	13.7/17.3
VFZ601A-4Z	2.3/3.4	5.6-5.8-6/6.5-6.3			21.1/27.5	9.81	3.2/4.4	2.3/3.4	5.6-5.8-6/6.5-6.3	18.2/23.6
VFZ701A-4Z	3.3/5.0	8.1-8-8/10-9.5			21.6/28.4	9.81	4.4/5.7	3.1/5.4	8.1-8-8/10-9.5	18.3/22.9
VFZ801A-4Z	5.0/7.0	11-10.5-10/14-13			25.5/33.3	9.81	6.3/8.5	5.2/7.6	11-10.5-10/14-13	21.6/26.6
VFZ901A-4Z	7.0/11.0	16-15.5-15/19-18			25.5/31.4	14.7	7.5/10.8	7.0/13	16-15.5-15/19-18	21.4/27.6

Model	Maximum delivery air quantity [m <sup>3</sup> /min]	Insulation class	Noise value [dB(A)]	Suction/delivery bore diameter [mm · inch]	Starting current [A]	Approximate mass [kg]
VFZ081PN	0.47/0.56	B	53.0/55.5			
VFZ101PN	0.58/0.69	B	48.5/51.5	32	4.0/3.8-4.2	5.5
VFZ201PN	0.86/1.05	B	55.0/59.5	32	9.4/9.2-10.0	8.5
VFZ301PN	1.25/1.45	B	55.5/59.5	38	14.5/13.0-14.5	12.0
VFZ401PN	2.05/2.45	B	62.5/66.5	38	18.5/17.5-19.5	12.0
VFZ081A	0.47/0.56	B	53.0/55.5	50, R1½	37.0/33.0-37.0	22.0
VFZ101A	0.58/0.69	B	52.5/56.5	32	2.0/2.0-2.2	5.5
VFZ201A	0.90/1.09	B	57.5/62.0	32	4.2/3.9-4.2	7.5
VFZ301A	1.28/1.40	B	58.0/62.0	32	9.0/8.1-9.0	9.0
VFZ401A	2.0/2.5	B	65.5/69.5	38	13.0/12.0-13.5	11.0
VFZ501A	3.4/4.0	F	70.5/74.5	50, R1½	27.0/25.0-27.5	19.0
VFZ601A	4.2/5.5	F	70.0/74.5	50, R1½	49/46-51	27.5
VFZ701A	6.2/7.2	F	75.0/79.5	63, R2	100/88-97	43
VFZ801A	8.7/10.3	F	78.0/81.0	Rp2	146/125-136	50
VFZ901A	13/15.5	F	79.5/83.0	Rp2½	175/160-170	89
VFZ101AF	0.58/0.69	B	52.5/56.5	Rp3	310/280-300	107
VFZ201AF	0.90/1.09	B	57.5/62.0	Rp1	4.2/3.9-4.2	7.5
VFZ301AF	1.28/1.40	B	58.0/62.0	Rp1	9.0/8.1-9.0	9.0
VFZ401AF	2.0/2.5	B	65.5/69.5	Rp1¼	13.0/12.0-13.5	11.0
VFZ501AF	3.4/4.0	F	70.5/74.5	Rp1½	27.0/25.0-27.5	19.0
VFZ601AF	4.2/5.5	F	70.0/74.5	Rp1½	49/46-51	27.5
VFZ701AF	6.2/7.2	F	75.0/79.5	Rp2	100/88-97	43
VFZ801AF	8.7/10.3	F	78.0/81.0	Rp2	146/125-136	50
VFZ901AF	13/15.5	F	79.5/83.0	Rp2½	175/160-170	89
VFZ101AN	0.58/0.69	B	49.5/51.5	32	4.2/3.9-4.2	9.0
VFZ201AN	0.90/1.09	B	55.5/59.0	32	9.0/8.1-9.0	10.0
VFZ301AN	1.28/1.40	B	55.5/59.5	38	13.0/12.0-13.5	13.0
VFZ401AN	2.0/2.5	B	62.0/66.0	50, R1½	27.0/25.0-27.5	22.0
VFZ501AN	3.4/4.0	F	66.0/69.5	50, R1½	49/46-51	34.0
VFZ601AN	4.2/5.5	F	67.5/70.5	63, R2	100/88-97	45.0
VFZ701AN	6.2/7.2	F	70.5/74.5	Rp2	146/125-136	62
VFZ801AN	8.7/10.3	F	74.0/75.0	Rp2½	175/160-170	98
VFZ901AN	13/15.5	F	76.0/79.5	Rp3	310/280-300	140
VFZ081A-4Z	0.47/0.56	B	53.0/55.5	32	1.0-1.1-1.1/1.0-1.1	5.5
VFZ101A-4Z	0.58/0.69	B	52.5/56.5	32	2.0-2.1-2.1/1.9-2.1	7.5
VFZ201A-4Z	0.90/1.09	B	57.5/62.0	32	3.6-3.9-4.0/3.4-3.7	9.0
VFZ301A-4Z	1.28/1.40	B	58.0/62.0	38	5.9-6.5-6.7/6.1-6.7	11.0
VFZ401A-4Z	2.0/2.5	B	65.5/69.5	50, R1½	13.0-13.5-14.0/12.5-14.0	19.0
VFZ501A-4Z	3.4/4.0	F	70.5/74.5	50, R1½	23.3-24.5-25.5/23.0-25.5	27.5
VFZ601A-4Z	4.2/5.5	F	70.0/74.5	63, R2	47.5-50.0-52.0/44.0-48.5	43.0
VFZ701A-4Z	6.2/7.2	F	75.0/79.5	Rp2	67-73-77/63-68	50
VFZ801A-4Z	8.7/10.3	F	78.0/81.0	Rp2½	83-88-92/80-85	89
VFZ901A-4Z	13/15.5	F	79.5/83.0	Rp3	132-134-144/119-130	107

The noise is the value at a position of 1.5m in an open state.  
The values with (1) mark are specified on nameplate.



## Guarantee Period and Scope of Guarantee -----

### <Product guarantee and scope of guarantee>

- The guarantee period of for product shall be 1 year after shipment to the specified destination. If any fault has occurred during the guarantee period in a proper use condition within the product specification range, the faulty part will be exchanged or repaired free of charge.
- However, if the fault corresponds to any of the following cases, it will be excluded from the scope of guarantee:

1) due to improper handling or use by the User

2) due to causes of fault other than of delivered product

3) due to improper repair or modification

4) due to natural calamity or disaster, which does not belong to the responsibility of supplier. The said guarantee means the guarantee for supplied product itself and we take no responsibility for the damage induced from the fault of the product.

### <Charged repair>

- The investigation and repair after the expiration of guarantee period will be charged. Even during the guarantee period, we accept the repair of fault and the cause investigation due to reasons out of the scope of guarantee for payment.

公司名称：上海梁瑾机电设备有限公司

联系人：盛志豪手机：**15021432841**

**QQ:208611419**

电话：**021-60538381** 传真：**021-57872573**

网址：**<http://www.liangjin-blower.com>**

**<http://www.lingjinsk.com> [www.liangjinjy.com](http://www.liangjinjy.com)**

地址：中国上海上海市松江区茜浦路 **850 弄 33 号**